

# Service Continuity Using UE-to-Network Relays

David Griffith, Wireless Networks Division

2nd Workshop on 5G Technologies for Tactical and First Responder Networks

7 October 2019

# Partial Coverage Scenario

Device-to-Device (D2D) communication allows User Equipment (Ues) to communicate with nearby units, but not all of them

If traffic is relayed to the network, more units can receive radio traffic

Network coverage may contain areas of weak/no signal, especially inside buildings or due to damaged infrastructures

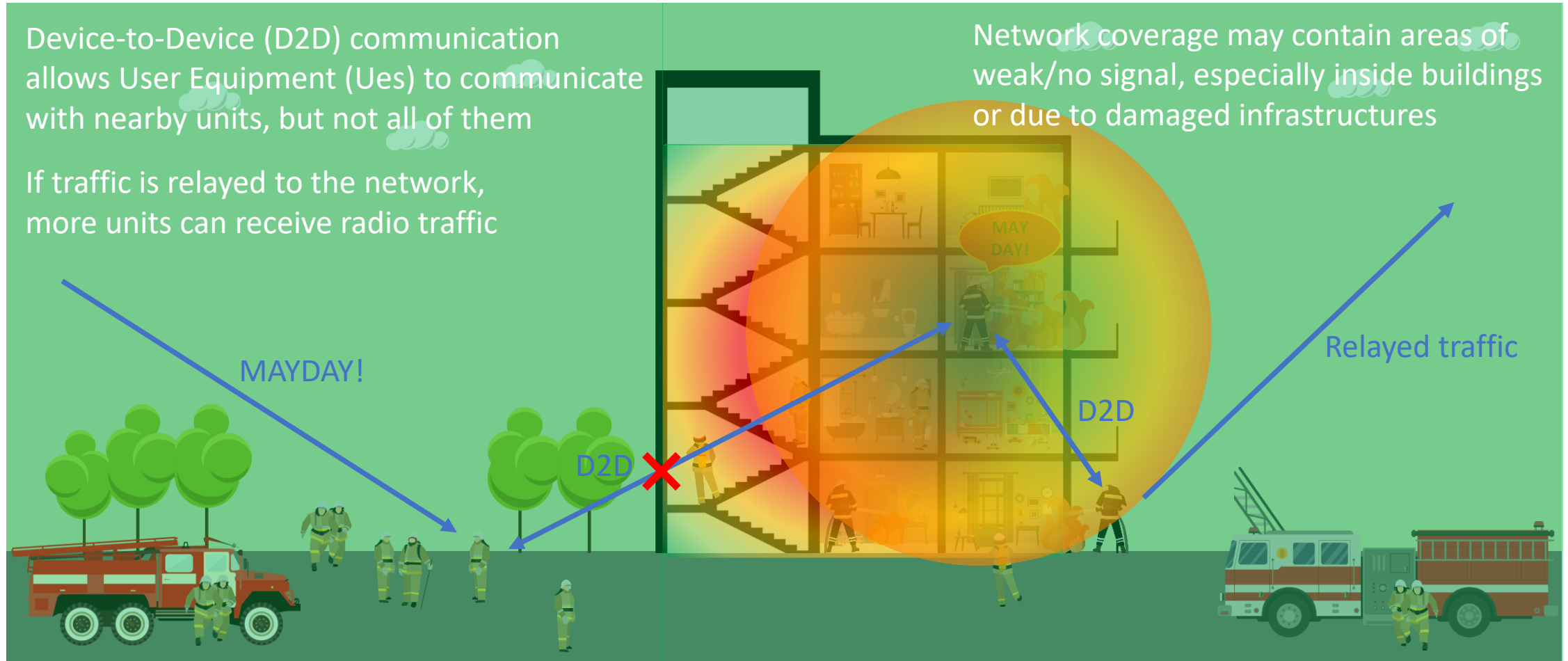

# UE-to-Network Relay Functions

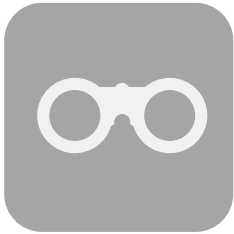

## Relay Discovery and Selection

- A UE losing connectivity with the network needs to discover the Relay UEs in proximity and select one to use



## Relay Connection Establishment

- The Remote UE exchanges signaling messages to establish a secure one-to-one link with the Relay UE



## Relay Communication

- The Relay UE does IP forwarding of packets between the network and the Remote UE

**How long will the process take?**

**What is the impact on the user's experience?**

**What are the major factors impacting performance?**

# Relay Discovery and Selection

Which discovery method to use?  
How many relays can be discovered?  
Which relay to select?



# Relay Discovery Protocol Operation

- Discovery message transmission
  - Periodical (from 0.32 s up to 10.24 s)
  - Use transmission probability
  - Select resource randomly

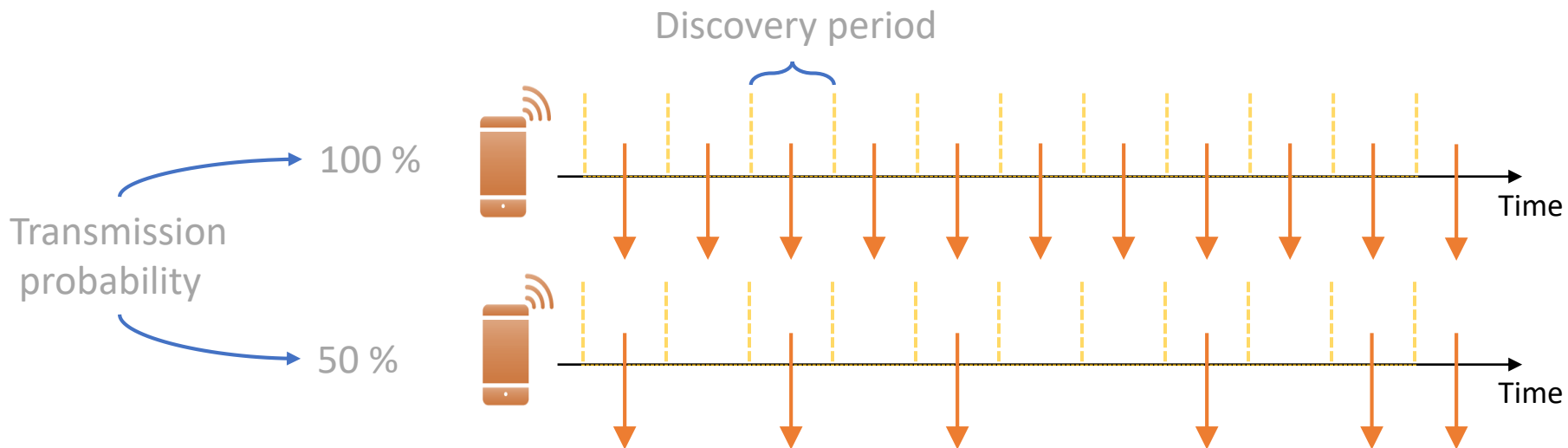

# Relay Discovery Protocol Challenges

- Performance constraints / potential problems
  - Collisions
  - Half-duplex

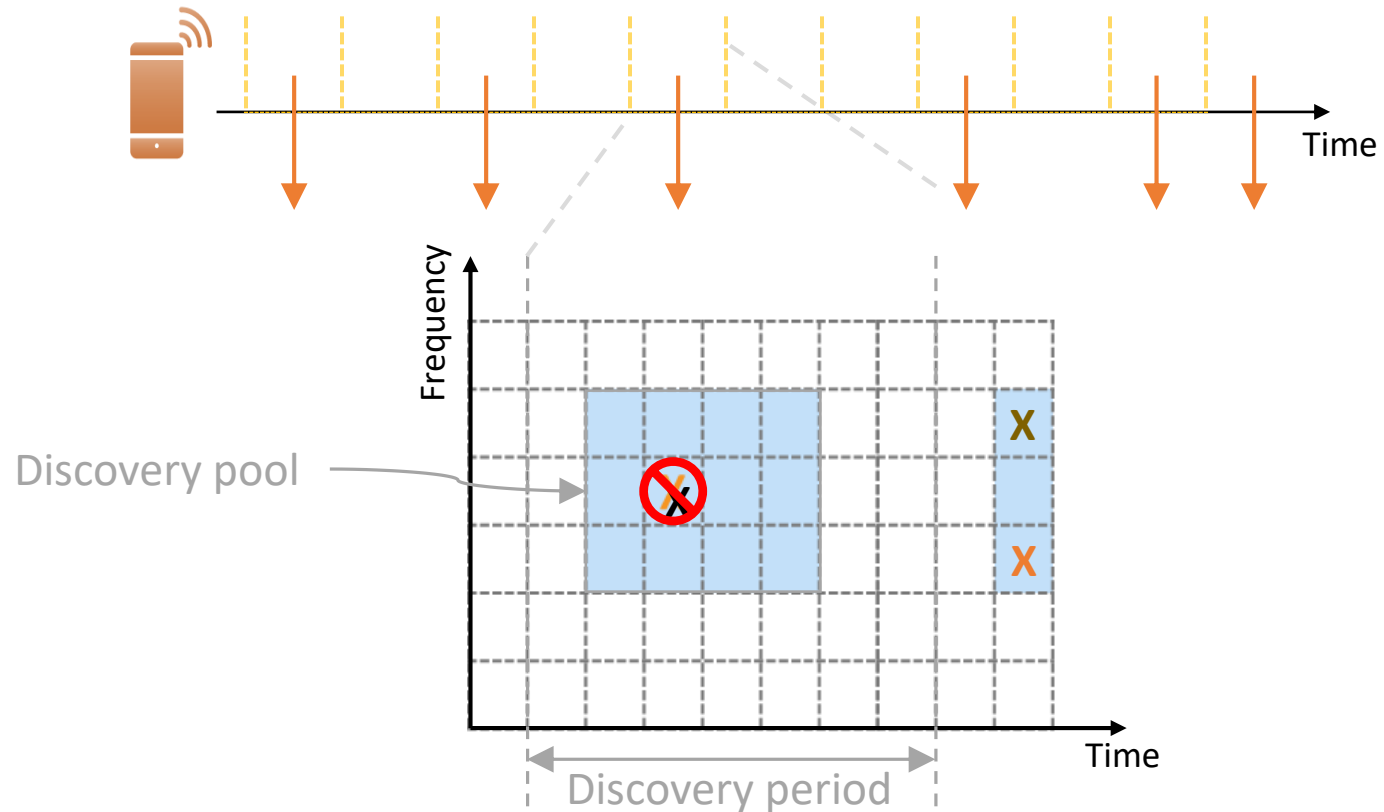

# Relay Discovery Modes

## Model A : Relay Announcement

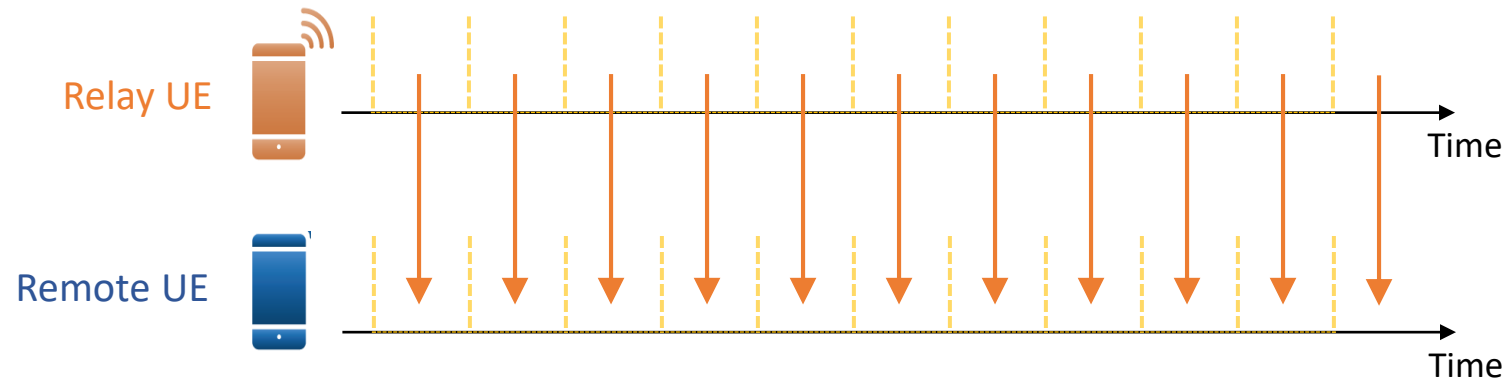

## Model B : Relay Solicitation (Remote UE) - Relay Response (Relay UE)

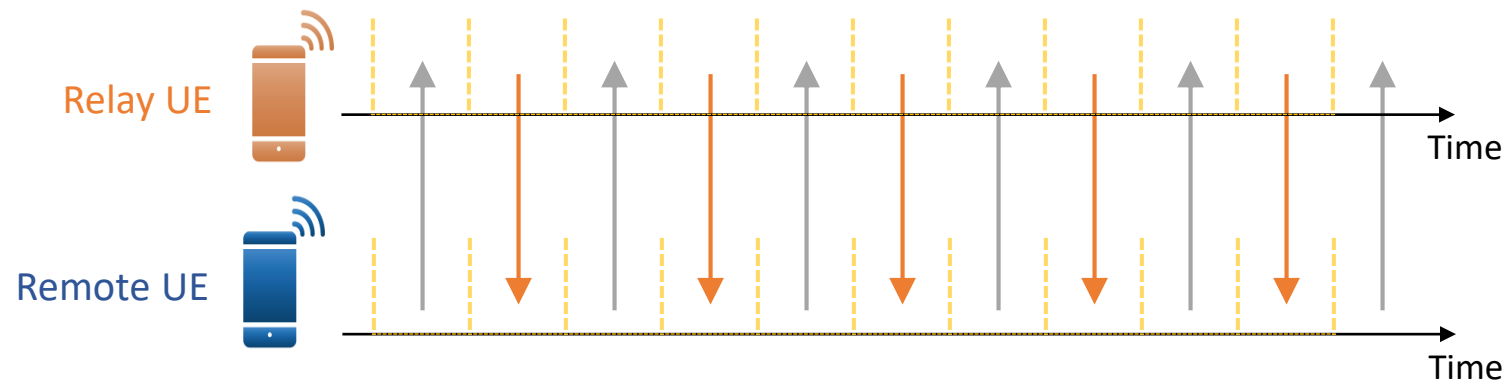

# Relay Selection Process

- Search for candidate relay UEs every discovery period
- Measurement of the candidate relays every 4 discovery periods
- Evaluation of the candidate relays within 16 discovery periods

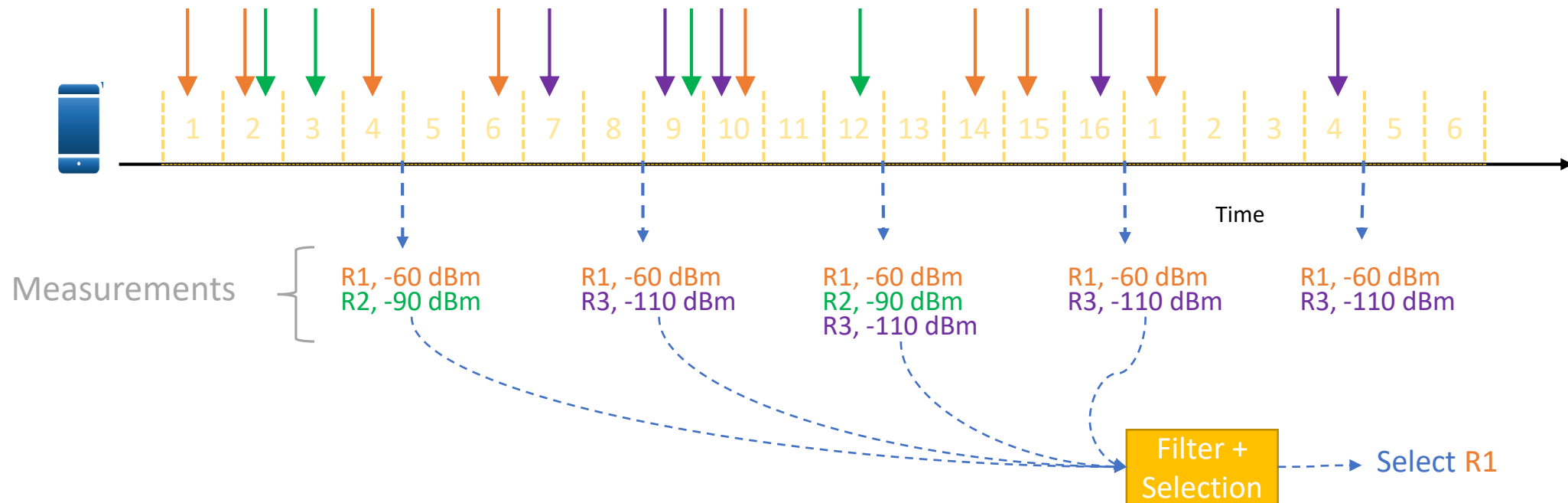



# Impact of Discovery on Relay Selection

Average Number of discovered Relays UEs in a measurement period (4 discovery periods) with 10 Remote UEs present

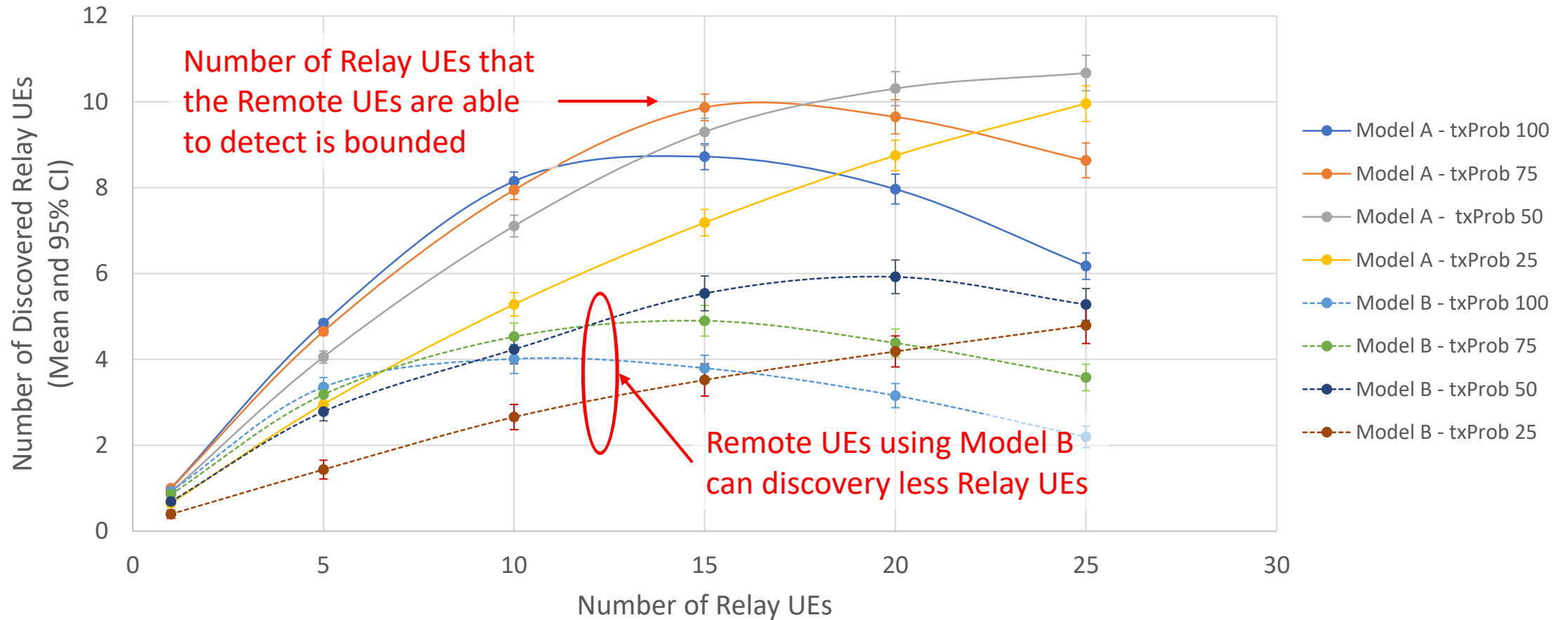

# Relay Connection Establishment

Is the Remote UE always successful at connecting to a Relay UE?  
How long does the connection process take?

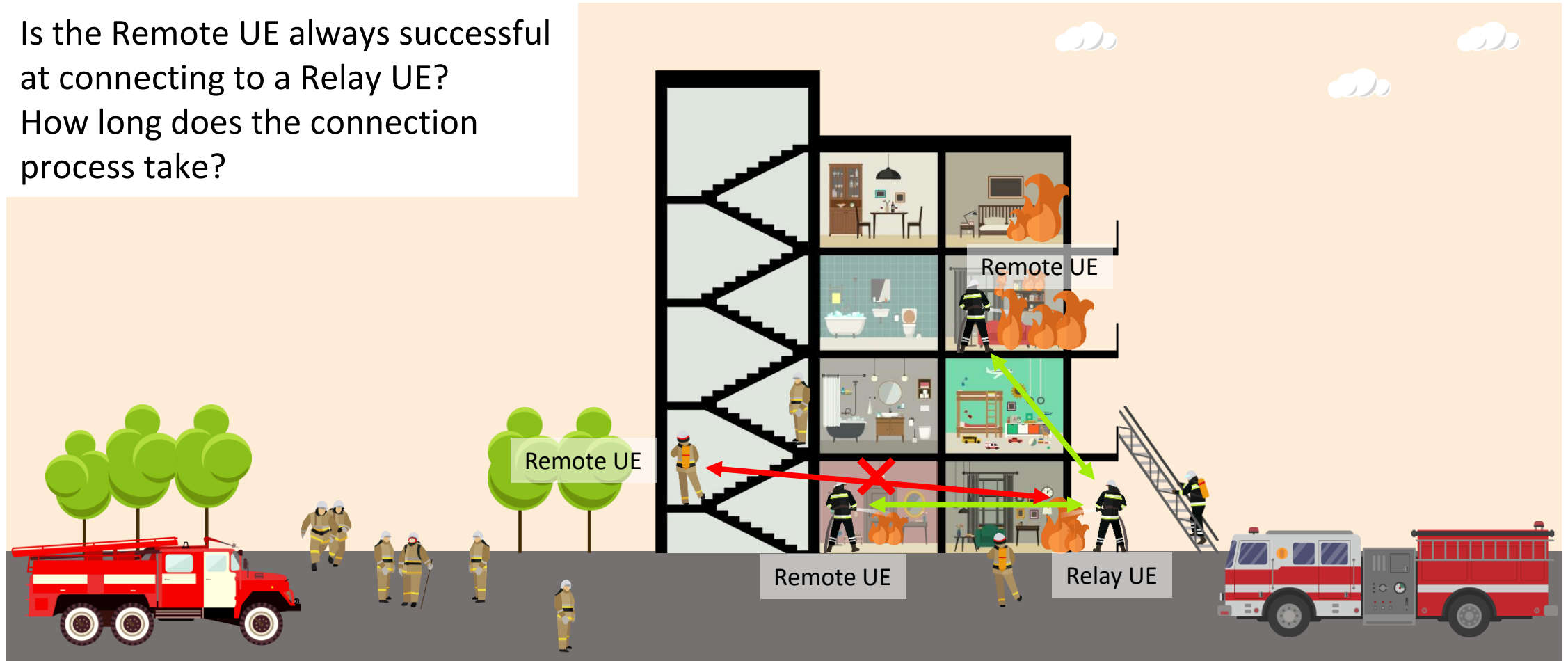

# Relay Connection Establishment

- Direct Communication Link Setup requires signalling between the Remote UE and the Relay UE
- If messages are lost, recovery mechanisms are available based on the following parameters:
  - Duration of Direct Communication Request retransmission timer (T4100)
  - Maximum number of Direct Communication Request retransmissions upon expiration of T4100

→ How to configure those parameters?

Direct Communication Link Setup Procedure

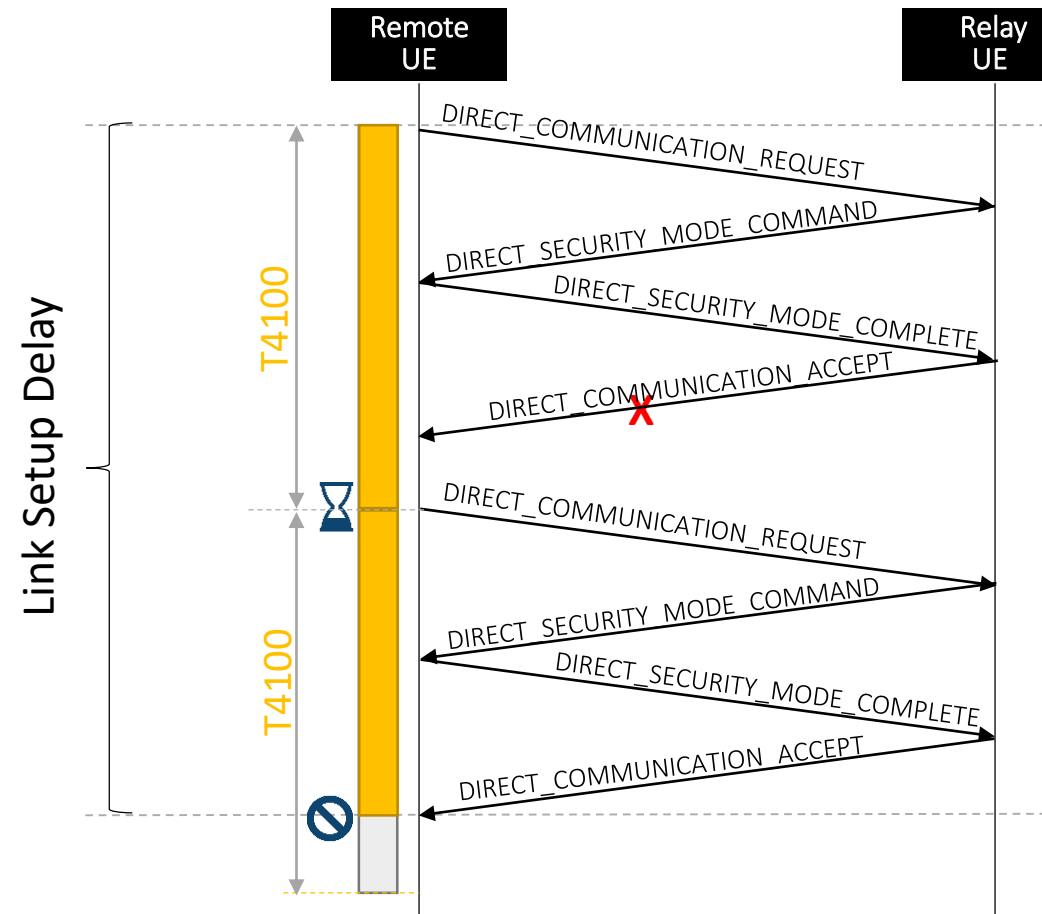

# Impact of T4100 and Retransmissions

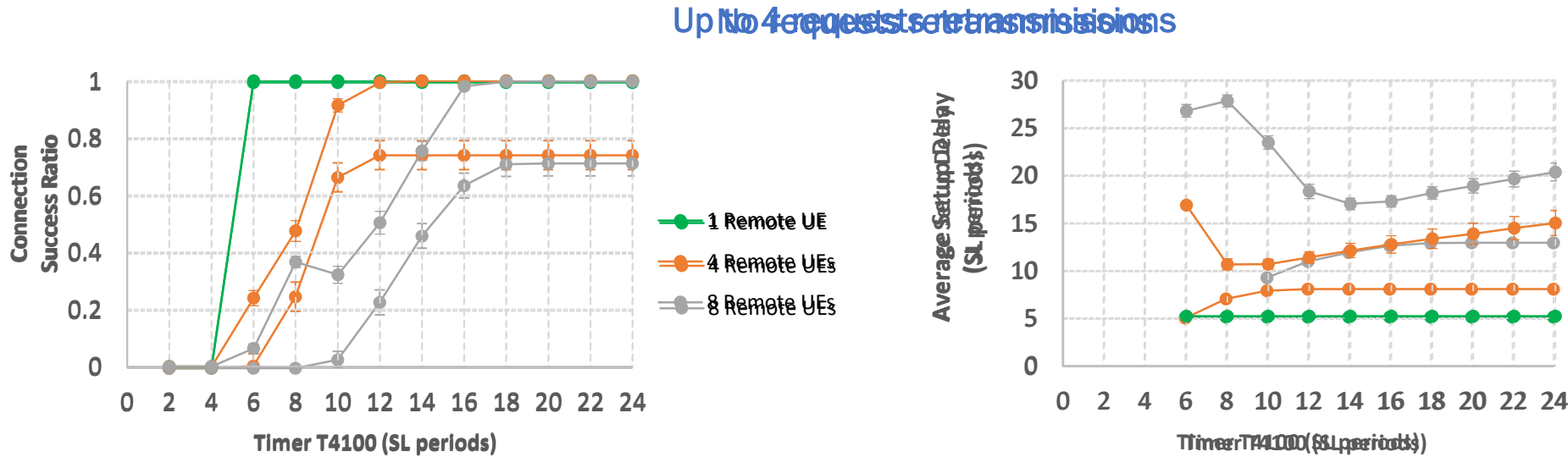

Results with no background UL traffic

		SL period length	
		0.04 s	0.32 s
Number of periods	5	0.20 s	1.60 s
	10	0.40 s	3.20 s
	20	0.80 s	6.40 s
	30	1.20 s	9.60 s

- The configuration of timer T4100 depends on the number of Remote UEs the Relay UE is communicating with in the Sidelink
- Retransmissions increase reliability but also latency
- Deployment must be considered when configuring protocols

# Impact of Uplink Occupancy

4 Remote UEs and T4100 = 16 SL periods

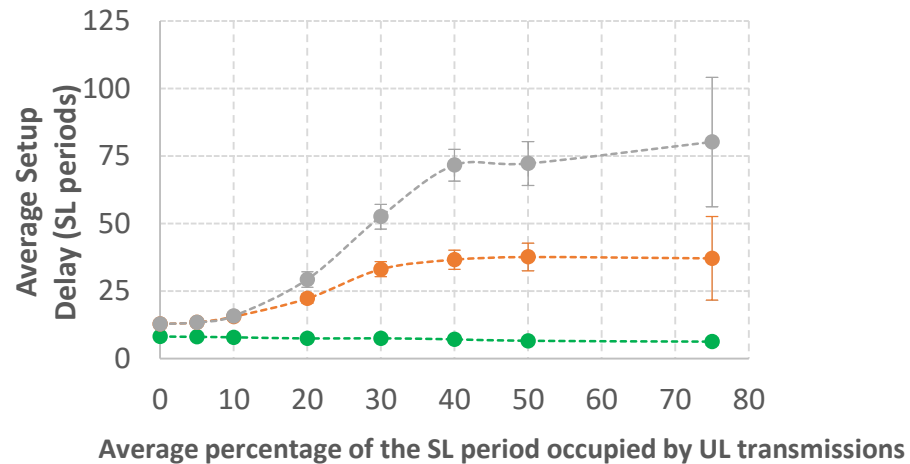
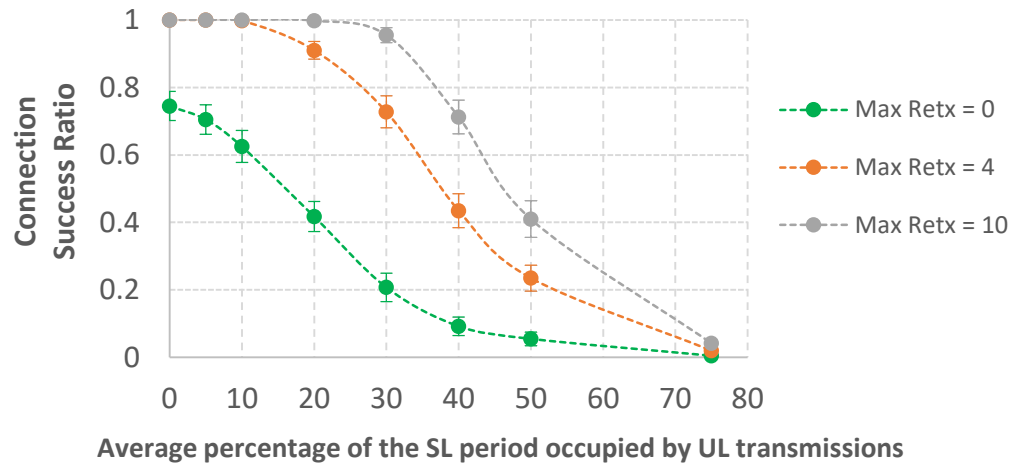

Results with UL traffic and no scheduling coordination between UL and SL

		SL period length	
		0.04 s	0.32 s
Number of periods	Connection time	10	10
	25	1.00 s	8.00 s
	50	2.00 s	16.00 s
	75	3.00 s	24.00 s

- Frequent uplink transmissions lower the sidelink connection reliability
  - Increasing the number of retransmission can mitigate the loss but cause significant delays
- Coordination between uplink and sidelink resource allocation is needed

# Relay Communication

What are the effects on application performance?  
Will the user experience be affected?

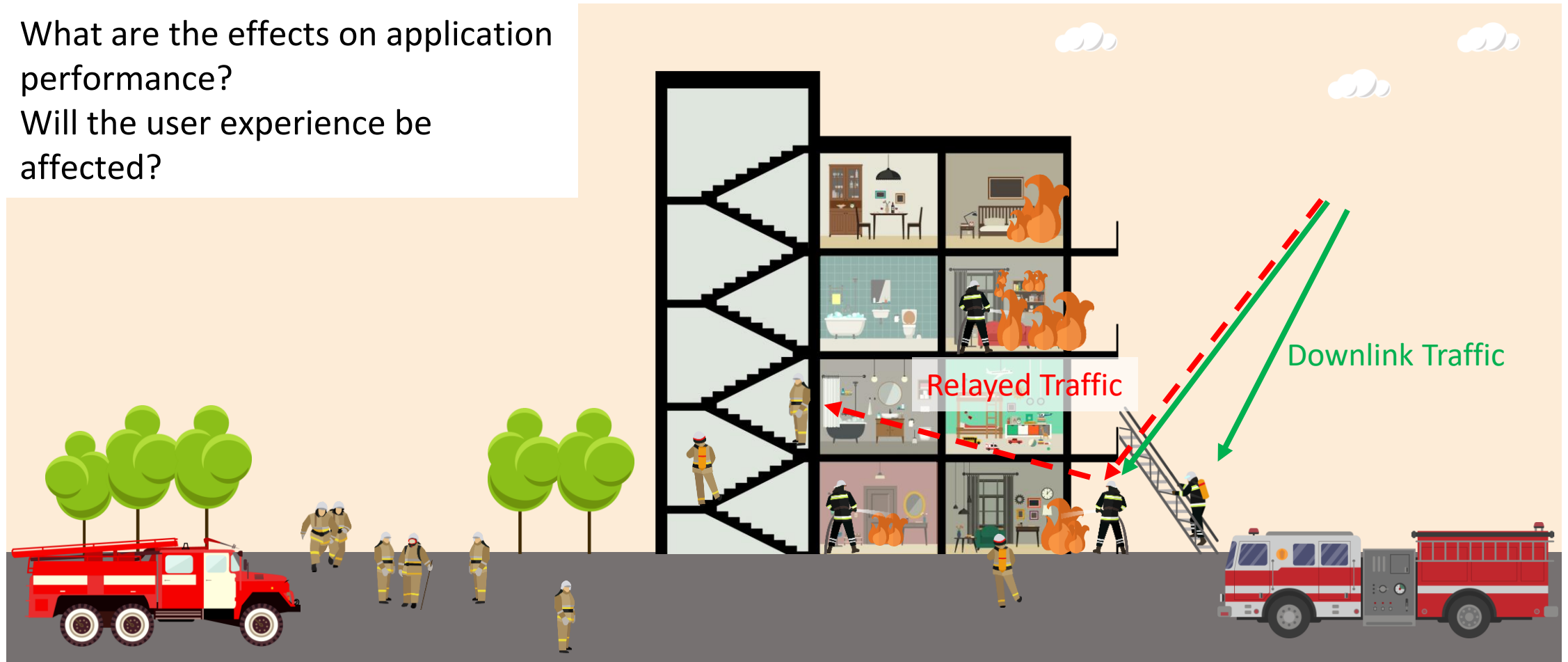

# Mission Critical Push-to-Talk (MCPTT)

## Performance Requirements



- 3GPP defines performance requirements for on network (TS 22.179)
  - **MCPTT Access time (KPI 1) less than 300 ms** for 95 % of all MCPTT Request.
  - **End-to-end MCPTT Access time (KPI 2) less than 1000 ms**
    - For users under coverage of the same network when the MCPTT Group call has not been established prior to the initiation of the MCPTT Request.
  - **Mouth-to-ear latency (KPI 3) that is less than 300 ms** for 95 % of all voice bursts.
  - Assumes negligible backhaul delay, max 70 % load, no transcoding

→ Can the same requirements be met when connected to a UE-to-Network relay?

# Relay Communication Paths

## Scenarios with group communication

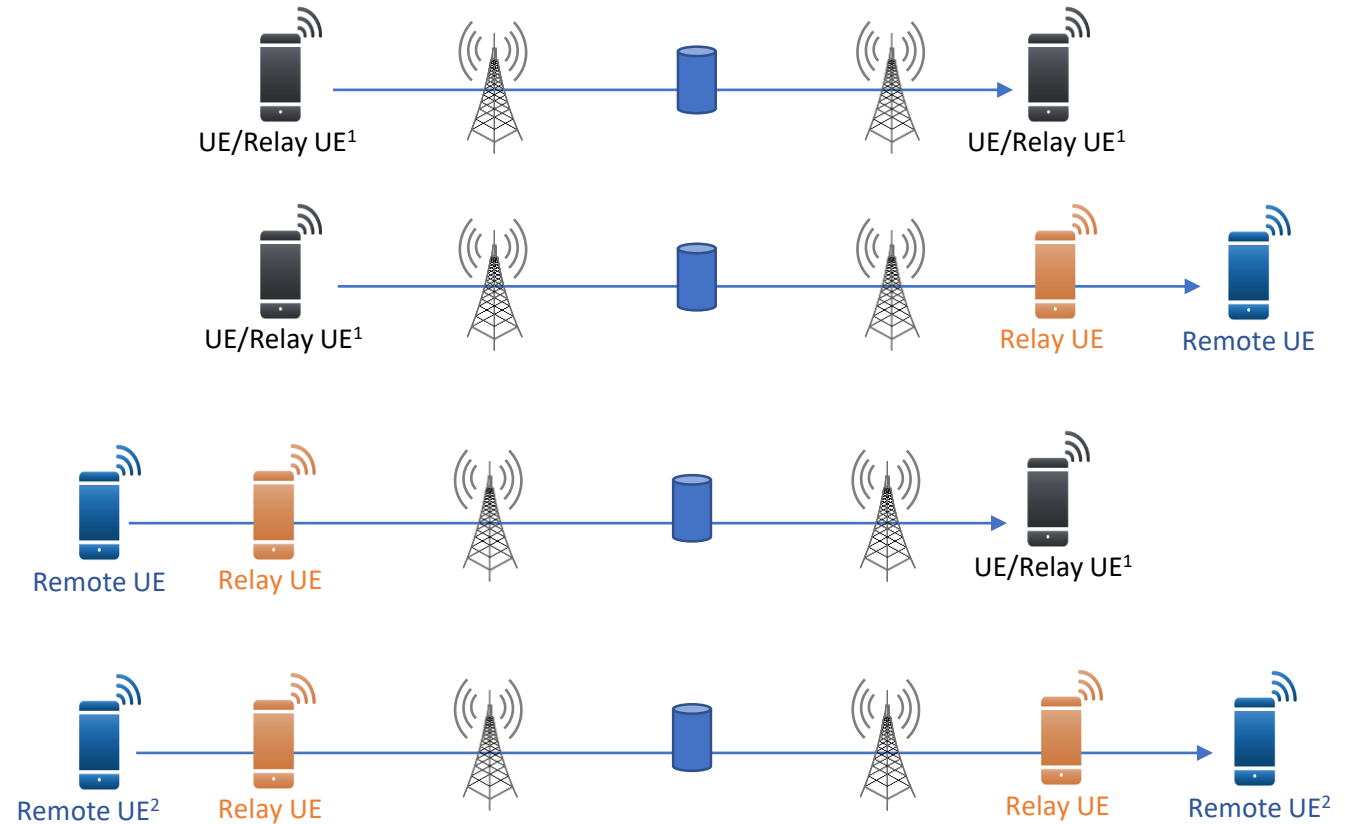
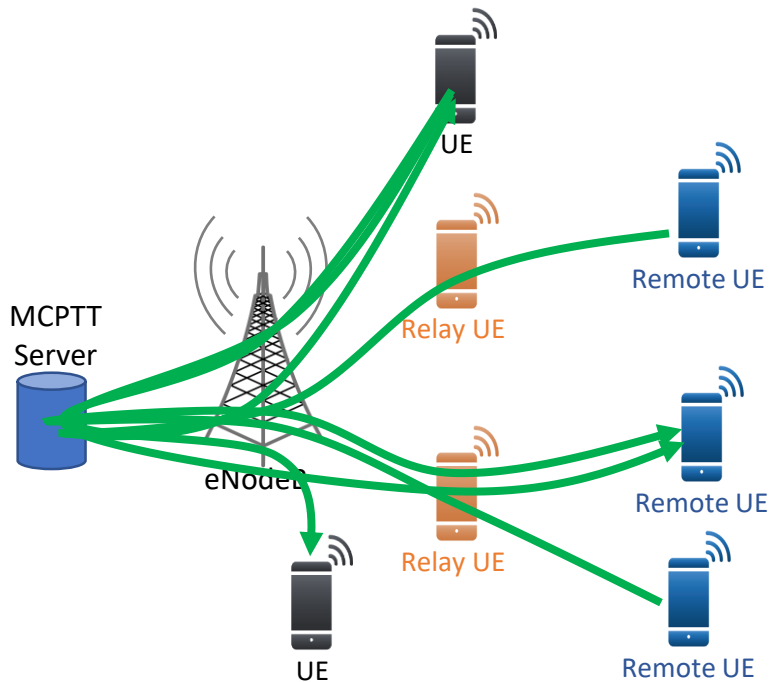

<sup>1</sup>While relay UEs are in coverage, delays to/from a relay UE might differ from that of a non-relay UE

<sup>2</sup>Performance will change whether the transmitter and receiver remote UEs are connected to the same relay or not



# Impact of Sidelink on Mouth-to-Ear Latency **NIST**

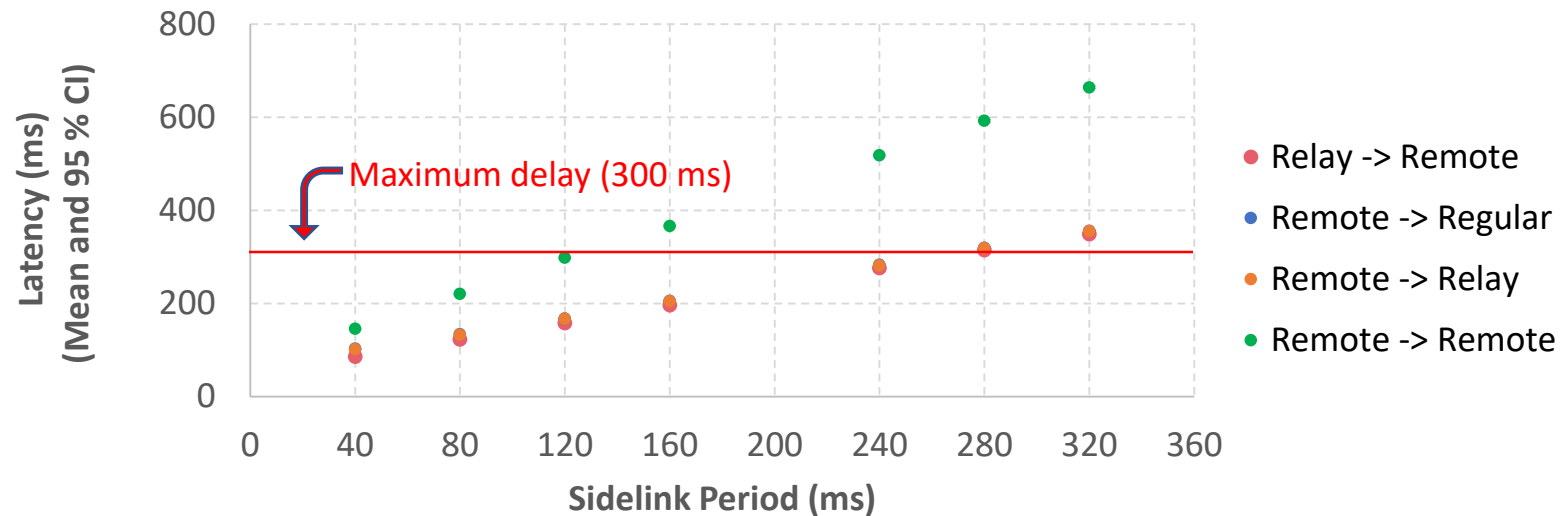

- Performance shown are for a network where only the media traffic is carried (no other load on the network)
  - When a Remote UE is involved, the higher the sidelink period, the larger the latency
- Sidelink period configuration must be configured considering end-to-end packet delay requirements

- UE-to-Network relays can help maintain connectivity for UEs losing coverage while in proximity of other UEs that are still in coverage
- Preliminary results show that performance are sensitive to several factors including:
  - Number of devices that can act as Relay UEs
  - Number of devices communicating with the Relay UEs
  - Sidelink configuration
  - Traffic load
- Users may notice some service degradation under certain conditions compared to on-network
- Our work will provide guidelines to configure the resources allocated to D2D and the protocol configurations to ensure proper operations

- Relay activation
  - Algorithms to detect when/where a relay might be needed
- Interference mitigation
  - Reduce collisions between uplink and sidelink
- Impact on energy consumption
  - Quantify additional energy cost to the relay nodes
- Protocol configuration
  - Guidelines for configuring timers and maximum number of retransmissions (i.e., keep alive, failure recovery)

# NIST D2D-Related Publications



1. S. Gamboa, A. Moreaux, D. Griffith, and R. Rouil, *"UE-to-Network Relay Discovery in ProSe-enabled LTE Networks"*, submitted to 2020 IEEE International Conference on Communications (ICC)
2. S. Gamboa, R. Thanigaivel, and R. Rouil, *"System Level Evaluation of UE-to-Network Relays in D2D-enabled LTE Networks"*, submitted to 2020 IEEE International Workshop on Computer Aided Modeling and Design of Communication Links and Networks (CAMAD)
3. S. Feng, H. Choi, D. Griffith, and R. Rouil, *"On Selecting Channel Parameters for Public Safety Network Applications in LTE Direct"*, in IEEE Consumer Communications & Networking Conference (CCNC), Las Vegas, Nevada, 10-13 January 2020.
4. J. Wang, R. Rouil, and F. Cintrón, *"Distributed Resource Allocation Schemes for Out-of-Coverage D2D Communications"*, in IEEE Global Communications Conference (GLOBECOM), Waikoloa, Hawaii, 9-14 December 2019.
5. D. Griffith, A. Ben-Mosbah, and R. Rouil, *"On Upper Bounds for D2D Group Size"*, in IEEE Global Communications Conference (GLOBECOM), Waikoloa, Hawaii, 9-14 December 2019.
6. A. Ben-Mosbah, D. Griffith, and R. Rouil, *"Enhanced Transmission Algorithm for Dynamic Device-to-Device Direct Discovery"*, in 2018 IEEE Consumer Communications and Networking Conference (CCNC), Las Vegas, Nevada, 12-15 January 2018.
7. D. Griffith, F. Cintrón, A. Galazka, T. Hall, and R. Rouil, *"Modeling and Simulation Analysis of the Physical Sidelink Shared Channel (PSSCH)"*, in IEEE International Conference on Communications (ICC), Kansas City, Missouri, 20-24 May 2018.
8. J. Wang and R. Rouil, *"Assessing Coverage and Throughput for D2D Communication"*, in IEEE International Conference on Communications (ICC), Kansas City, Missouri, 20-24 May 2018.
9. A. Ben-Mosbah, D. Griffith, and R. Rouil, *"Enhanced Transmission Algorithm for Dynamic Device-to-Device Direct Discovery"*, in IEEE Consumer Communications and Networking Conference (CCNC), Las Vegas, Nevada, 12-15 January 2018.
10. D. Griffith, F. Cintrón, A. Galazka, T. Hall, and R. Rouil, *"Modeling and Simulation Analysis of the Physical Sidelink Shared Channel (PSSCH)"*, in IEEE International Conference on Communications (ICC), Kansas City, Missouri, 20-24 May 2018.

# NIST D2D-Related Publications (cont.)



11. J. Wang and R. Rouil, *"Assessing Coverage and Throughput for D2D Communication"*, in IEEE International Conference on Communications (ICC 2018), Kansas City, Missouri, 20-24 May 2018.
12. D. Griffith, *"Modeling Device-to-Device Communications for Wireless Public Safety Networks,"* in IEEE 5G Workshop for Tactical and First Responder Networks, Johns Hopkins University Applied Physics Laboratory, 23 October 2018.
13. F. Cintrón, *"Performance Evaluation of LTE Device-to-Device Out-of-Coverage Communication with Frequency Hopping Resource Scheduling"* NIST Interagency/Internal Report (NISTIR) 8220. 23 July 2018.
14. R. Rouil, F. J. Cintrón, A. Ben-Mosbah, and S. Gamboa, *"Implementation and Validation of an LTE D2D Model for ns-3,"* in Workshop on ns-3 (WNS3 2017), Porto, Portugal, 13-14 June 2017.
15. S. Gamboa, F.J. Cintrón, D. Griffith, and R. Rouil, *"Impact of timing on the Proximity Services (ProSe) synchronization function"*, in IEEE Consumer Communications & Networking Conference (CCNC), Las Vegas, Nevada, 8-11 January 2017.
16. D. Griffith, A. Ben-Mosbah, and R. Rouil, *"Group Discovery Time in Device-to-Device (D2D) Proximity Services (ProSe) Networks"*, in IEEE International Conference on Computer Communications (INFOCOM), Atlanta, Georgia, 1-4 May 2017.
17. A. Ben-Mosbah, D. Griffith, and R. Rouil, *"A Novel Adaptive Transmission Algorithm for Device-to-Device Direct Discovery"*, in IEEE Wireless Communications and Networking Conference (WCNC), San Francisco, California, 19-22 March 2017.
18. D. Griffith, F. Cintrón, and R. Rouil, *"Physical Sidelink Control Channel (PSCCH) in Mode 2: Performance Analysis"*, in IEEE International Conference on Communications (ICC), Paris, France, 21-25 May 2017.
19. S. Gamboa, F.J. Cintrón, D.W. Griffith, and R.A. Rouil, *"Adaptive synchronization reference selection for out-of-coverage Proximity Services (ProSe)"* in 28th Annual IEEE International Symposium on Personal, Indoor and Mobile Radio Communications (PIMRC), Montreal, Canada, 8-13 October 2017.
20. D. Griffith and F. Lyons, *"Optimizing the UE Transmission Probability for D2D Direct Discovery,"* in IEEE Global Communications Conference (GLOBECOM), Washington, DC, 4-8 December 2016.
21. J. Wang and R. Rouil, *"BLER Performance Evaluation of LTE Device-to-Device Communications,"* NIST Interagency/Internal Report (NISTIR) 8157, November 2016.